

JUAL Extension pipe



Application:

For a tight and secure solution for extending roof outlet pipes.

Material:

Extension pipe: (stainless steel)
Lip Seal (EPDM)

Type	Ø (mm)	Length	Item no
JUAL Extension pipe	50 mm	300 mm	(457050-300)
JUAL Extension pipe	50 mm	600 mm	(457050-600)
JUAL Extension pipe	62 mm	300 mm	(457062-300)
JUAL Extension pipe	62 mm	600 mm	(457062-600)
JUAL Extension pipe	75 mm	300 mm	(457075-300)
JUAL Extension pipe	75 mm	600 mm	(457075-600)
JUAL Extension pipe	80 mm	300 mm	(457080-300)
JUAL Extension pipe	80 mm	600 mm	(457080-600)
JUAL Extension pipe	90 mm	300 mm	(457090-300)
JUAL Extension pipe	90 mm	600 mm	(457090-600)
JUAL Extension pipe	95 mm	300 mm	(457095-300)
JUAL Extension pipe	95 mm	600 mm	(457095-600)
JUAL Extension pipe	110 mm	300 mm	(457110-300)
JUAL Extension pipe	110 mm	600 mm	(457110-600)
JUAL Extension pipe	125 mm	300 mm	(457125-300)
JUAL Extension pipe	125 mm	600 mm	(457125-600)
JUAL Extension pipe	145 mm	300 mm	(457145-300)
JUAL Extension pipe	145 mm	600 mm	(457145-600)
JUAL Extension pipe	160 mm	300 mm	(457160-300)
JUAL Extension pipe	160 mm	600 mm	(457160-600)

Technical specifications:

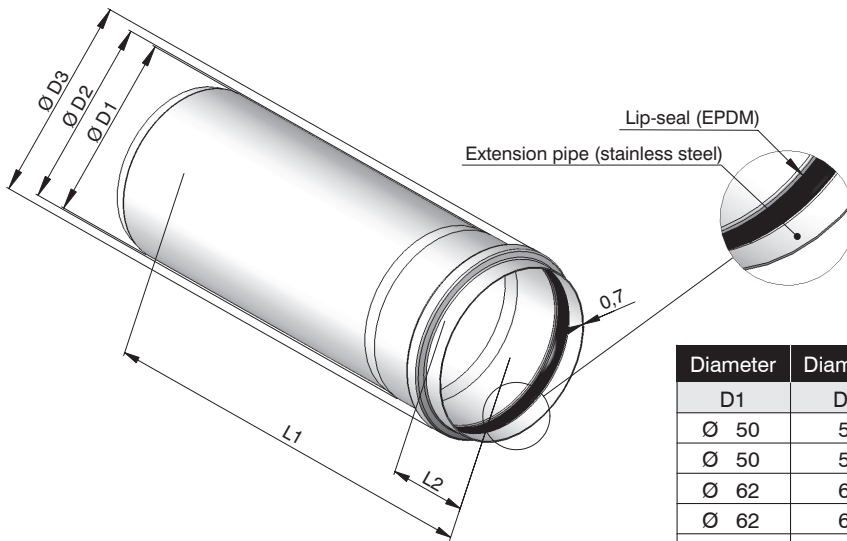

Diameter	Diameter	Diameter	Pipe length	Socket length
D1	D2	D3	L1	L2
Ø 50	54	60	300	70
Ø 50	54	60	600	70
Ø 62	66	72	300	70
Ø 62	66	72	600	70
Ø 75	79	85	300	70
Ø 75	79	85	600	70
Ø 80	84	90	300	70
Ø 80	84	90	600	70
Ø 90	94	100	300	70
Ø 90	94	100	600	70
Ø 95	99	105	300	70
Ø 95	99	105	600	70
Ø 110	114	120	300	70
Ø 110	114	120	600	70
Ø 125	129	135	300	70
Ø 125	129	135	600	70
Ø 145	149	154	300	70
Ø 145	149	154	600	70
Ø 160	164	169	300	70
Ø 160	164	169	600	70

Installation:

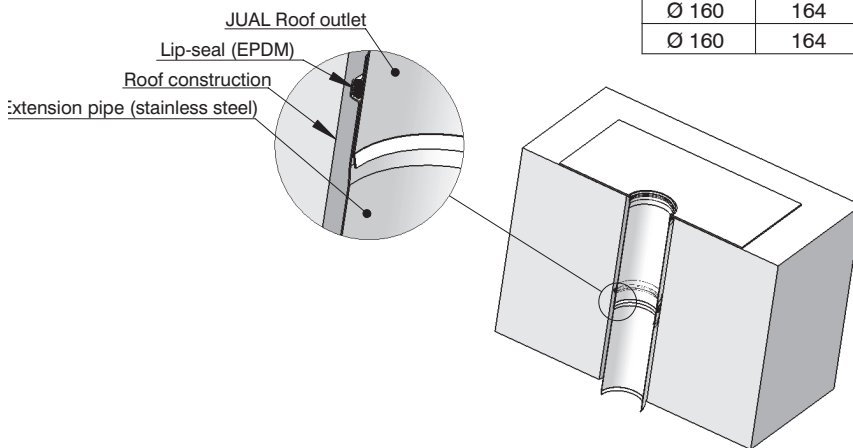

General information

The pipe is produced in compliance with the guidelines described in EN1124, which outline the current requirements for the production of stainless steel pipes.